

SONOFF 4CHPRO 4 Gang WiFi Smart Switch User Manual

[Home](#) » [SonOFF](#) » SONOFF 4CHPRO 4 Gang WiFi Smart Switch User Manual

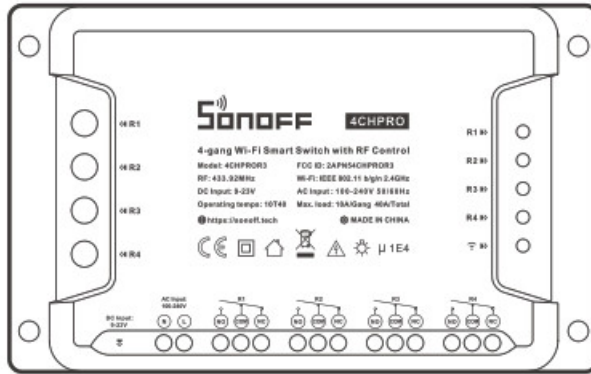

DIY 4CH/4CHPRO
4-gang Wi-Fi Smart Switch
User manual V1.1

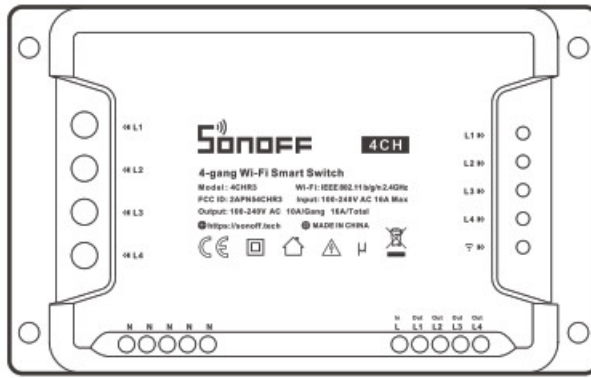

Contents [[hide](#)]

- [1 Operating Instruction](#)
- [2 Compatible Pairing Mode](#)
- [3 Specifications](#)
- [4 Product Introduction](#)
- [5 Wi-Fi LED indicator status instruction](#)
- [6 Features](#)
- [7 RF Remote Controller Pairing](#)
- [8 Switch Network](#)
- [9 Factory Reset](#)
- [10 Common Problems](#)
- [11 Documents / Resources](#)

Operating Instruction

1. Power off

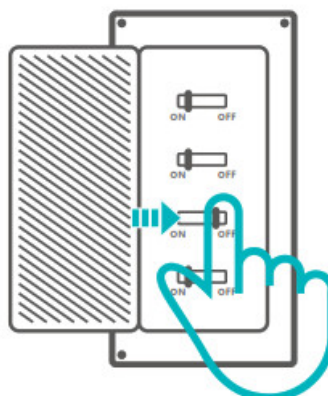

To avoid electric shocks, please consult the dealer or a qualified professional for help when installing

and repairing!

2. Wiring instruction

Light fixture wiring instruction:

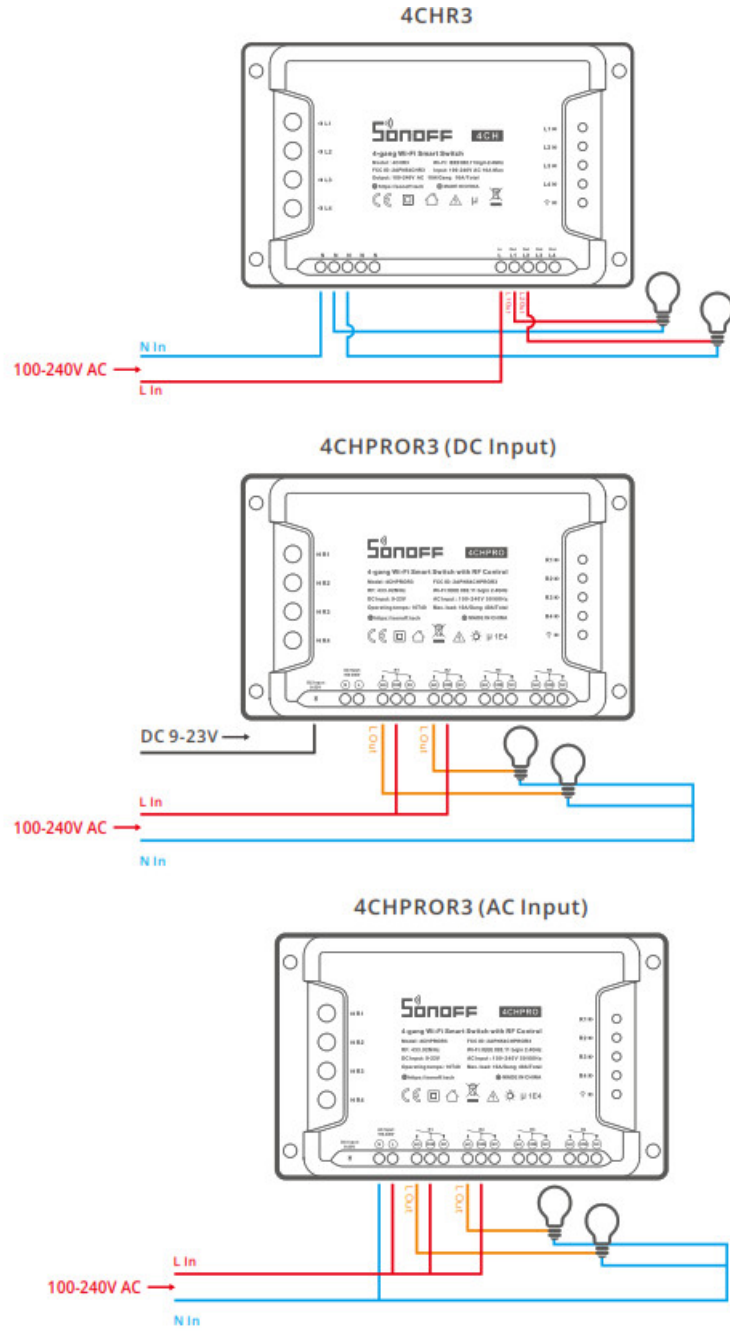

Socket wiring instruction (Don't need to connect if no ground wire):

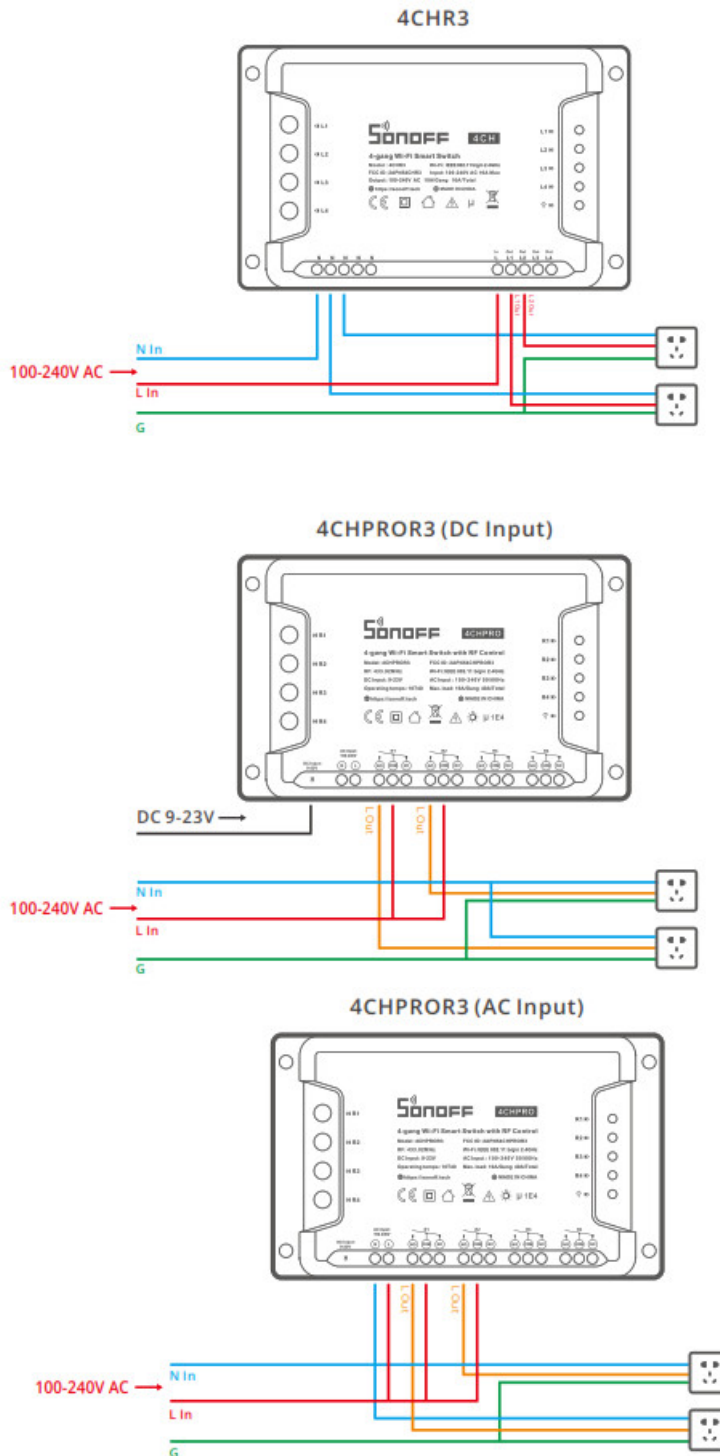

Make sure all wires are connected correctly.

3. Download the eWeLink APP

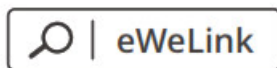

Android™ & iOS

<http://app.coolkit.cc/dl.html>

4. Power on

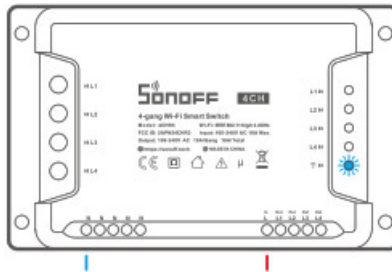

After powering on, the device will enter the quick pairing mode (Touch) during the first use. The Wi-Fi LED indicator changes in a cycle of two short and one long flash and release.



The device will exit the quick pairing mode (Touch) if not paired within 3mins. If you want to enter this mode, please long press any pairing button for about 5s until the Wi-Fi LED indicator changes in a cycle of two short and one long flash and release.

5. Add the device

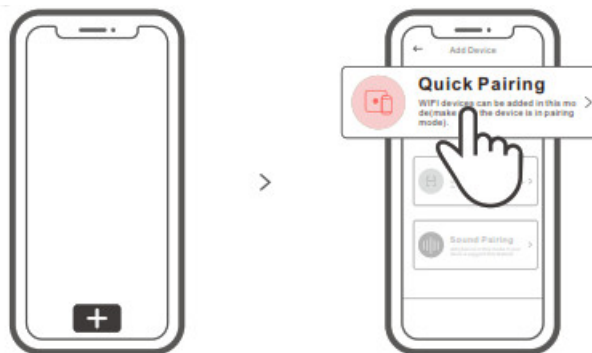

Tap “+” and select “Quick Pairing”, then operate following the prompt on the APP.

Compatible Pairing Mode

If you fail to enter Quick Pairing Mode (Touch), please try “Compatible Pairing Mode ” to pair.

1. Long press any pairing button for 5s until the Wi-Fi LED indicator changes in a cycle of two short flashes and one long flash and release. Long press any pairing button for 5s again until the Wi-Fi LED indicator flashes quickly. Then, the device enters Compatible Pairing Mode.
2. Tap “+” and select “ Compatible Pairing Mode ” on APP.
Select Wi-Fi SSID with ITEAD-***** and enter the password 12345678, and then go back to eWeLink APP and tap “Next”. Be patient until pairing completes.

Specifications

Model	4CHR3/4CHPROR3
Input	4CHR3: 100-240V AC 50/60Hz 4CHPROR3: 100-240V AC 50/60Hz (DC: 9-23V)
Max. Load	4CHR3: 10A/2200W/Gang 16A/3500W/Total 4CHPROR3: 10A/2200W/Gang 40A/8800W/Total
RF	433.92MHz
Wi-Fi	IEEE 802.11 b/g/n 2.4GHz
Operating systems	Android & iOS
Working temperature	-10°C~40°C
Material	PC V0
Dimension	145x90x34mm

! CHR3 does not support the remote controller with 433.92MHz.

Product Introduction

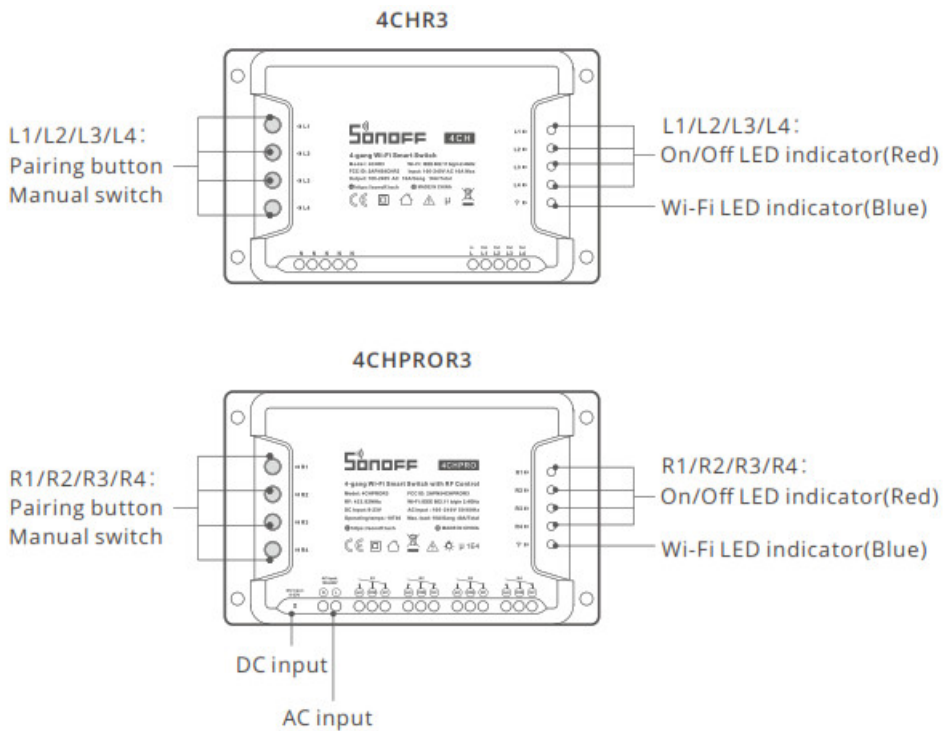

! The device's weight is less than 1 kg.
An installation height of less than 2 m is recommended.

Wi-Fi LED indicator status instruction

Wi-Fi LED indicator status	Status instruction
Flashes (one long and two short)	Quick Pairing Mode
Keeps on	Device is connected successfully
Flashes quickly	Compatible Pairing Mode
Flashes quickly once	Unable to discover the router
Flashes quickly twice	Connect to the router but fail to connect to Wi-Fi
Flashes quickly three times	Upgrading

Features

This device is a 4-Gang Wi-Fi smart switch with self-locking, interlock and inching that allow you to remotely turn on/off connected devices via your smartphone, schedule on or off, share to your family to control together.

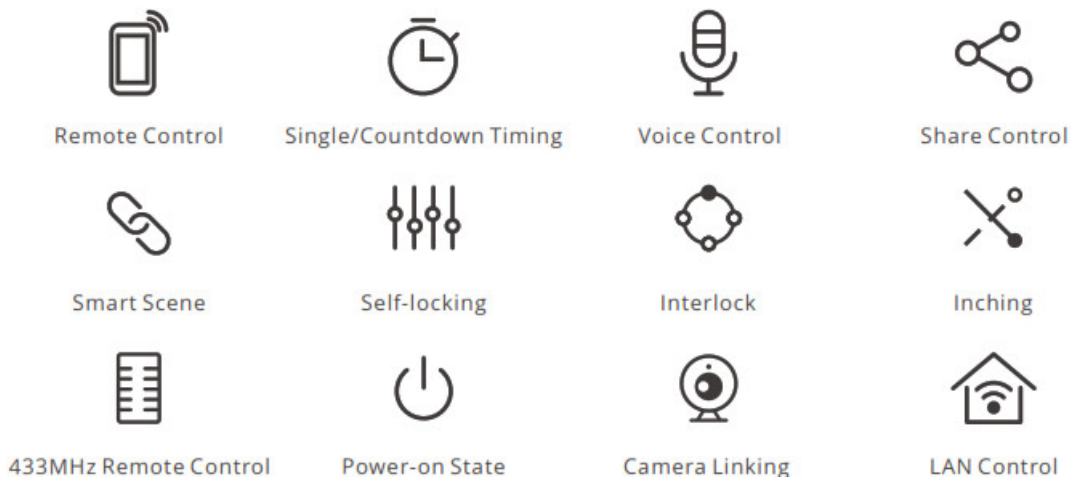

RF Remote Controller Pairing

The 4CHPROR3 supports the remote controller with a 433.92MHz frequency band to turn on/off, and each channel can learn it independently, which is local short-range wireless control, not Wi-Fi control.

Pairing Method:

Long press the channel switch button to be paired for 3s until the Wi-Fi LED indicator turns red and “quickly flashes once” and release, then short press the button to be paired on the remote control. If the Wi-Fi LED indicator turns red and “quickly flashes once”, it indicates that the pairing is successful. Z

Clearing Method:

Long press the channel switch button to be cleared for 5s until the Wi-Fi LED indicator turns red and “quickly flashes twice” and release, then short press the button to be cleared on the remote control. If the Wi-Fi LED indicator turns red and “quickly flashes once”, it indicates that the code is cleared.

Switch Network

If you need to change the network, Long press any pairing button for about 5s until the Wi-Fi LED indicator changes in a cycle of two short and one long flash and release, then the device enters quick pairing mode and you can pair again.

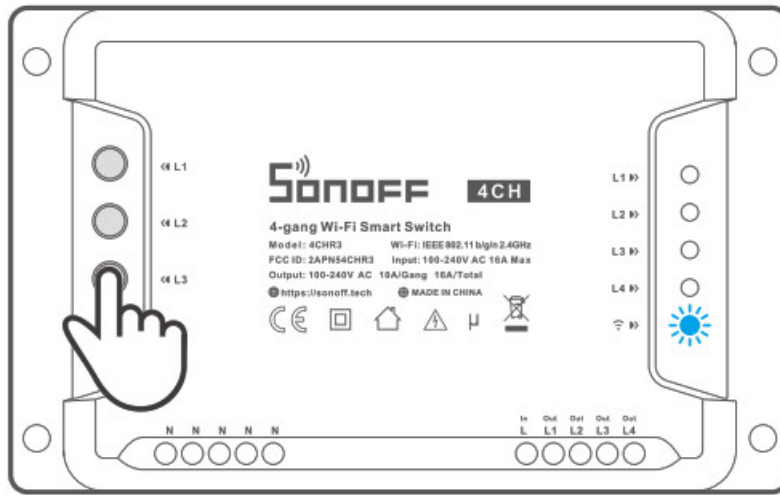

Factory Reset

Deleting the device on the eWeLink app indicates you restore it to the factory setting.

Common Problems

Q: Why my device stays “Offline”?

A: The newly added device needs 1 – 2mins to connect Wi-Fi and network. If it stays offline for a long time, please judge these problems by the blue Wi-Fi indicator status:

1. The blue Wi-Fi indicator quickly flashes once per second, which means that the switch failed to connect your Wi-Fi:

- ① Maybe you have entered the wrong Wi-Fi password.
- ② Maybe there's too much distance between the switch your router or the environment causes interference, consider getting close to the router. If failed, please add it again.
- ③ The 5G Wi-Fi network is not supported and only supports the 2.4GHz wireless network.
- ④ Maybe the MAC address filtering is open. Please turn it off.

If none of the above methods solved the problem, you can open the mobile data network on your phone to create a Wi-Fi hotspot, then add the device again.

2. Blue indicator quickly flashes twice per second, which means your device has connected to Wi-Fi but failed to connect to the server.

Ensure a steady enough network. If double flash occurs frequently, which means you access an unsteady network, not a product problem. If the network is normal, try to turn off the power to restart the switch.

FCC Warning

Changes or modifications not expressly approved by the party responsible for compliance could avoid the user's authority to operate the equipment.

This device complies with part 15 of the FCC Rules. Operation is subject to the following two conditions: (1) This device may not cause harmful interference, and (2) this device must accept any interference received, including interference that may cause undesired operation.

FCC Radiation Exposure Statement:

This equipment complies with FCC radiation exposure limits set forth for an uncontrolled environment. This equipment should be installed and operated with a minimum distance 20cm between the radiator & your body. This transmitter must not be co-located or operating in conjunction with any other antenna or transmitter.

Note:

This equipment has been tested and found to comply with the limits for a Class B digital device, pursuant to part 15 of the FCC Rules. These limits are designed to provide reasonable protection against harmful interference in a residential installation. This equipment generates, uses, and can radiate radio frequency energy and, if not installed and used in accordance with the instructions, may cause harmful interference to radio communications. However, there is no guarantee that interference will not occur in a particular installation. If this equipment does cause harmful interference to radio or television reception, which can be determined by turning the equipment off and on, the user is encouraged to try to correct the interference by one or more of the following measures:

- Reorient or relocate the receiving antenna.
- Increase the separation between the equipment and receiver.
- Connect the equipment into an outlet on a circuit different from that to which the receiver is connected.
- Consult the dealer or an experienced radio/TV technician for help.

Hereby, Shenzhen Sonoff Technologies Co., Ltd. declares that the radio equipment type SlampherR2 is in compliance with Directive 2014/53/EU. The full text of the EU declaration of conformity is available at the following internet address:

<https://sonoff.tech/usermanuals>

TX Frequency:

WiFi: 2412-2472MHz

RX Frequency:

WiFi: 2412-2472MHz SRD: 433.92MHz

Output Power:

15.55dBm

16.3dBm(802.11b), 17.16dBm(802.11g), 17.38dBm(802.11n20)



Shenzhen Sonoff Technologies Co., Ltd.

1001, BLDG8, Lianhua Industrial Park, Shenzhen, GD, China

ZIP code: 518000 Website: sonoff.tech

MADE IN CHINA

**Documents / Resources**

The cover of the user manual for the Sonoff 4CHPRO 4 Gang WiFi Smart Switch. It features the Sonoff logo, the product name "DIY 4CH/4CHPRO", and a technical drawing of the switch. A table of contents is visible at the bottom.	<p>SONOFF 4CHPRO 4 Gang WiFi Smart Switch [pdf] User Manual 4CH, 4CHPRO, 4CHPRO 4 Gang WiFi Smart Switch, 4 Gang WiFi Smart Switch</p>
---	---

