

INSTRUCTION MANUAL

FLOOD SENSOR

— FIBARO SYSTEM —



Technical support

Should you need any assistance in connecting or configuring your Home Center, please use our guides and technical presentations which can be found on our website:

<http://www.fibaro.com/en/support>

Functional features



Flood sensor

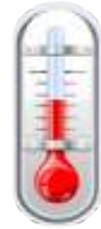

Temperature sensor



Signal and
light alarm



Tilt sensor

Download FIBARO app for smartphone



Start the device

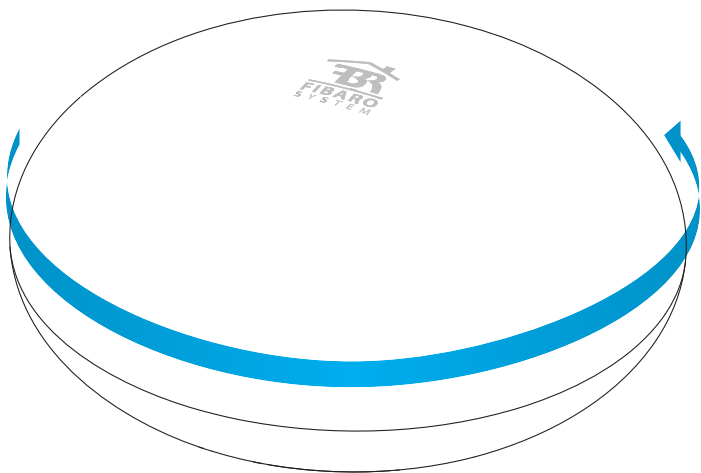

STEP 1
Twist and open the casing.

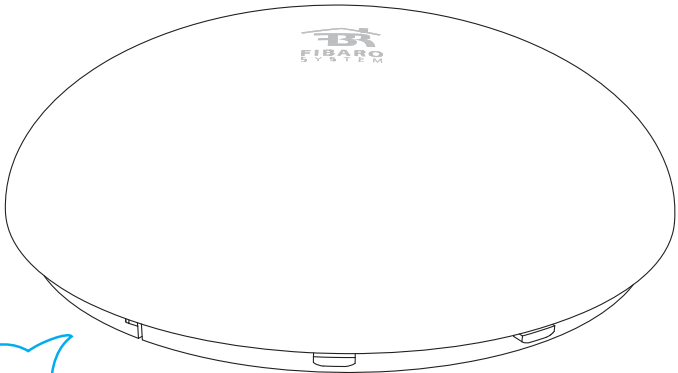

STEP 2
Take off the casing.

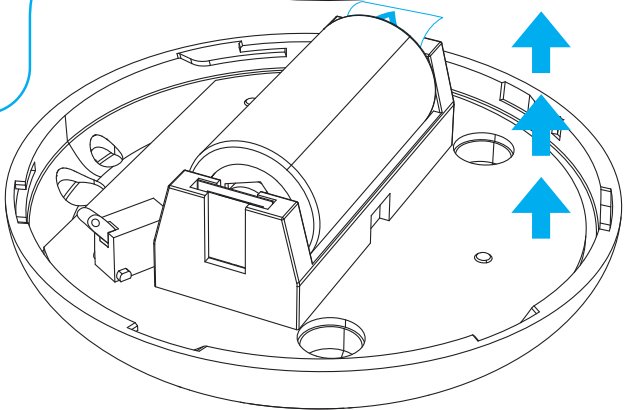

Start the device

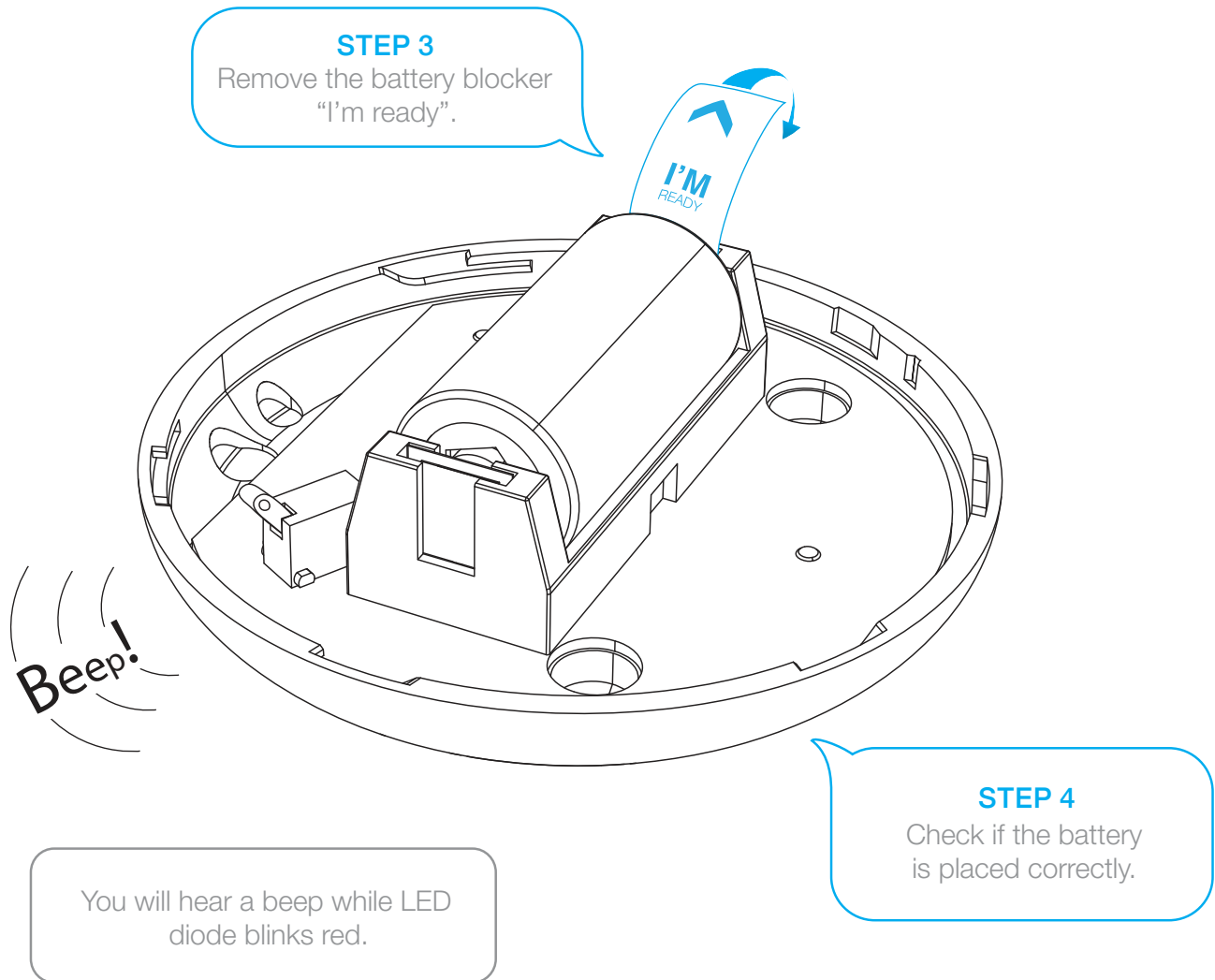

Your Flood Sensor is ready to be added to the Home Center.

Flood Sensor must be in range of the Home Center because it requires a direct communication with the controller.



Start inclusion mode

STEP 5

Start your FIBARO application.
Go to Settings.

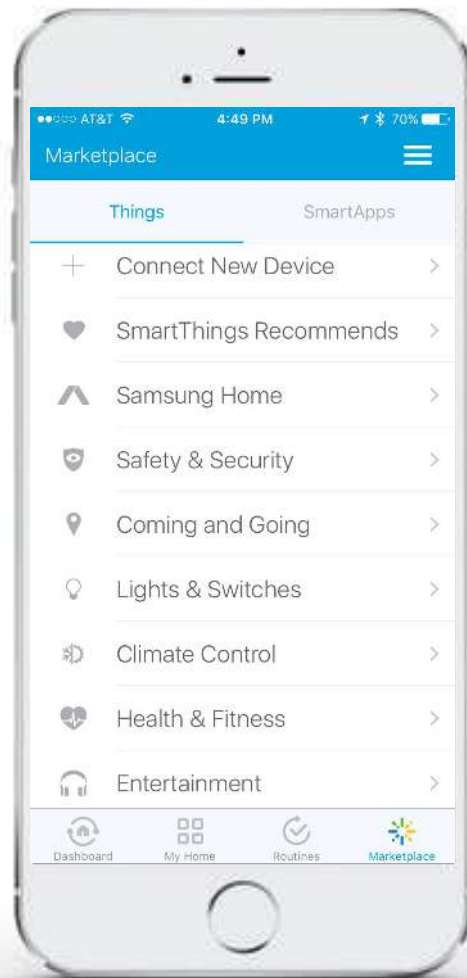

Start inclusion mode

STEP 6

Press "add device".



STEP 7

Press "Next".

Inclusion mode has been launched



Add your device

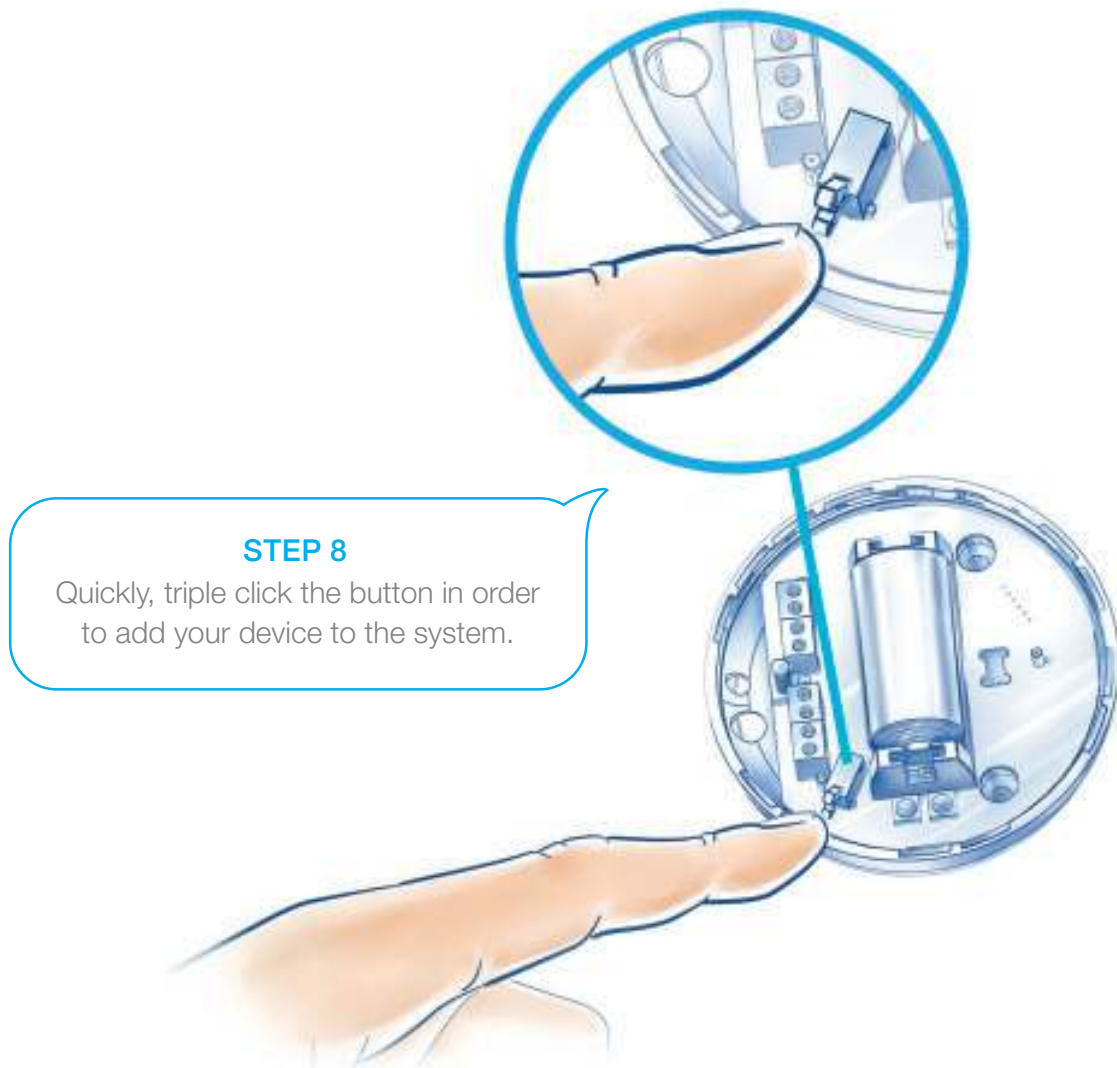

Processing your configurations



Wake up the device



Sometimes waking up the device is not required so it will be omitted automatically.



STEP 9

Quickly, triple click the button in order to wake up the device.



The device has been added



STEP 10

Name the device and assign it to the room.



Network range test

It is recommended to check if the device's destination is in range of your Home Center.

STEP 11

Hold the button for about 10-15 seconds until LED diode blinks violet.

STEP 12

Release the button, and press it again.



The quality of the network range will be indicated by different colours of the LED diode.

Network range test – quality indicator



Direct communication



Routed communication



Limited communication



No signal! The device will not work correctly!



STEP 13

Press the button in order to leave testing mode.



Close the casing

STEP 14
Close and twist the cover.

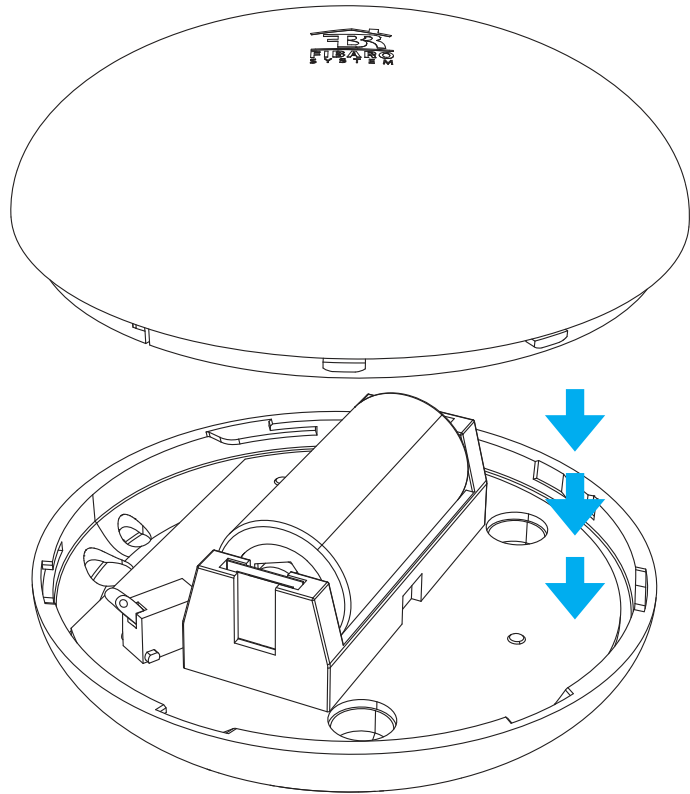

Installation

During the installation it is recommended to wake up the device.



1. FIBARO Flood Sensor should be installed in all spaces, where's the risk of flood:
 - In the bathroom,
 - In the kitchen,
 - At the basement.
2. Additional security informs about accidental location change (every time it changes its location in information is being sent to Home Center).
3. A built-in temperature sensor lets you monitor e.g. floor's temperature.

Adding a probe

If the sensor cannot fit the space which is in danger of flooding you can install a wired probe* that will get to difficult to access spaces.



*The probe is not included in the Flood Sensor set.



www.fibaro.com